

KP Bolt Interlock with Safety Switch

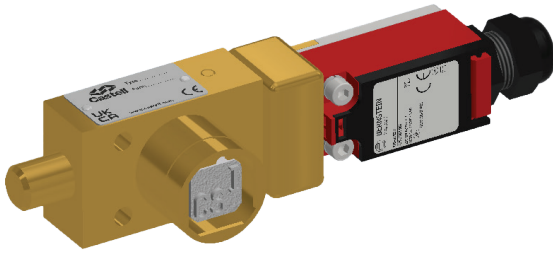

The KP bolt interlock is a key operated mechanical bolt interlock complete with position monitoring electrical contacts for the control of electrical switchgear or valves. The KP lock comes with a 16 mm diameter bolt of variable length, that is used to control the rotation or movement of operating handles or toggles. The KP1 comes with 2N/C 1N/O 10 amp contacts and the KP2 has 4N/C 2N/O 10 amp contacts, these are used to provide remote indication of the bolt position or to switch the control circuitry on the machine. The locks are manufactured in brass or stainless steel.

OPERATION

The Castell KP bolt interlock with safety switches is used in switchgear control to break circuitry and inhibit movement of cams, toggles or levers simultaneously.

KP bolt interlock with safety switch, rear entry, form 4

1 Key is trapped, bolt is retracted.

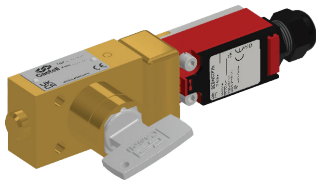

While the power is on, the key is trapped the side bolt is retracted. The KP switch contacts are opened.

2 Turn and release key to drive the bolt and change the switch contacts condition.

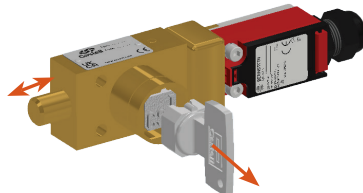

Turning the key drives the bolt to extended position, e.g. locking off the movement of a disconnector. Turning the key also changes the contacts in the KP switch, which is connected to a traffic light or other display. The display then indicates that the access can be gained in the machine area. The released key can now be taken to open the door lock to the machine area.

3 Key is free, bolt is extended, switch contacts are reversed.

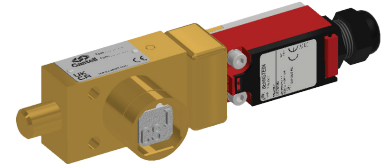

The power disconnector cannot be unlocked until the key is replaced and turned in the KP bolt interlock.

The KP bolt interlock is available as a KP1 or KP2 version with either one or two safety switches respectively. The KP bolt interlock is available with as rear or front entry mounted switch (panel or surface mount respectively).

The length of the bolt is available in various lengths to suit the application, but the travel of the bolt is always 19.05 mm. The key is trapped when the bolt is extended. Rotation of the key anti clockwise will retract the bolt and change contacts in the switch.

USAGE

The KP bolt interlock with safety switch should be used to allow safe control of valves or disconnect switches.



The KP bolt interlock is not designed for security purposes, such as access to a building.

INSTALLATION

The housing of the KP Bolt Interlock can be mounted either to a panel or on a surface using suitable fasteners. Please refer to drawing on page 4 for more details.



IMPORTANT: The interlock should be mounted using anti-tamper fasteners to prevent unauthorised removal.



The KP bolt interlock must be installed by a competent and qualified person who has read and understood these instructions. Please retain this document in your technical file.



Force required to shear lock bolt is 30 KN for stainless steel and 19 KN for brass interlocks.



You must use M6 anti-tamper stainless steel screws secured using threadlock set to a torque of 5 N/M.



The manufacturer should be consulted when use in a corrosive environment is planned.

MAINTENANCE

Periodic visual checks should be carried out by the site manager / safety officer.

Do not lubricate lock barrel with oil or grease, use CK dry powder graphite if necessary.



In case of defects being detected please contact your nearest Castell Support Department for further actions. Please see Contact section for contact details.



The interlock must be inspected every 6 months. Safety checks should include ensuring the keys and lock bolt can only be operated in the correct safety operating conditions (see page 1).

KP Bolt Interlock with Safety Switch

TECHNICAL DATA

| | |
|------------------------------|--|
| Temperature rating | -30°C ice free to +80°C |
| Type of mounting | Panel or surface mount using suitable fasteners (please refer to drawing on page 4 for more details) |
| Weight | KP1: 0.8 kg |
| | KP2: 1 kg |
| Material | Brass/Stainless steel |
| Switch approvals | CSA, UL, VDE |
| B10d | 2,000,000 |
| PL rating | PLd |
| Shock & vibration | In accordance with BS EN 60068-2-6 & BS EN 60068-2-27 |
| Switch standards | IEC 60947-1 IEC 60947-5-1 |
| Switch protection | IP65 |
| Cable gland | M20 |
| Switch rating | 240 V, 10 amps |

APPLICATION

KP bolt interlock safety component with safety switches are used as part of an integrated safety system, typically in switchgear applications.

The electrical supply of the machine is on, and the protective door to the hazardous area is locked. The key is trapped in the KP bolt interlock. Before entering the machine area the disconnecter lever needs to be rotated to isolate the machine. To lock the disconnecter lever in the safe position the key in the KP bolt interlock needs to be turned extending the bolt of the KP. Removing the key traps the bolt in the extended position. The operation of the KP also changes the contacts in the KP switch. This is connected to a traffic light or another display, indicating the access to machine area can be gained.

The removed key is taken to the AI access interlock to open the door. The power supply cannot be switched back on while the key is trapped in the access interlock.

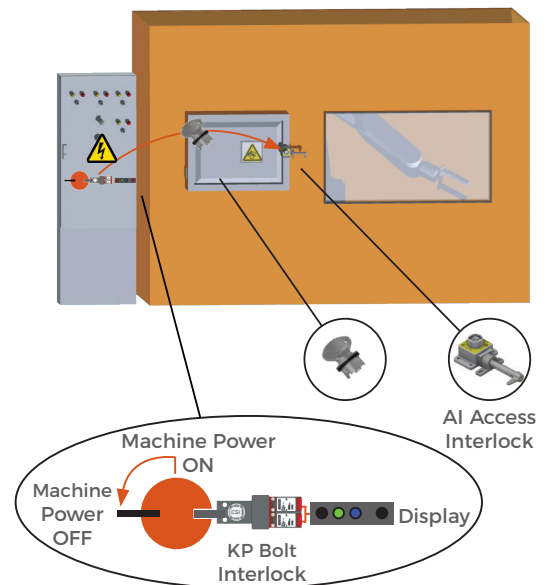

KP Bolt Interlock with Safety Switch

DRAWING

Dimensions: in mm

Note: For safe mounting, use security screws

KP2, Rear Mounted Switch

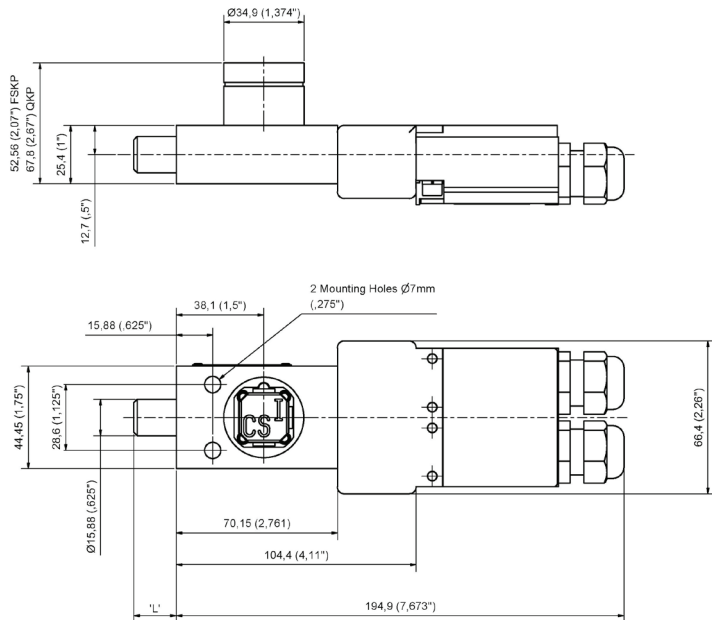

KP1, Front Mounted Switch

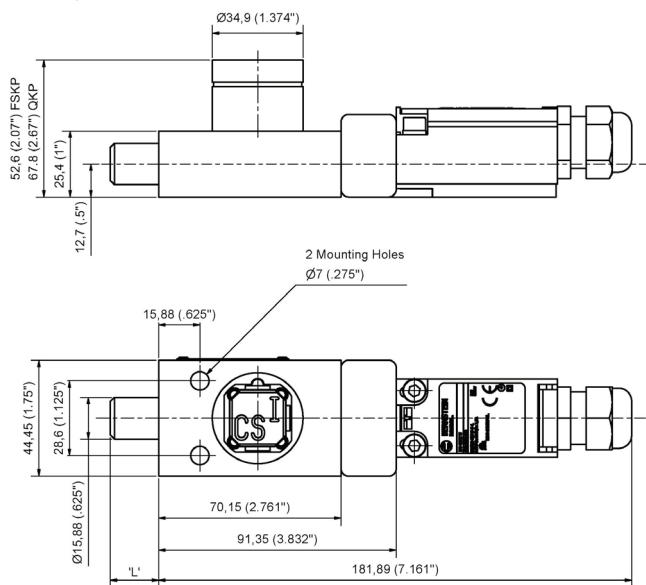

| L Dimension Retracted bolt length (in mm) | Extended bolt length (in mm) |
|--|------------------------------|
| 0 | 19.05 |
| 6.35 | 25.40 |
| 12.70 | 31.75 |
| 19.05 | 38.10 |
| 25.40 | 44.45 |

KP Bolt Interlock with Safety Switch

WIRING DIAGRAM

Key Free, Bolt is Extended: 2 N/C + 1 N/O (KP1)
4 N/C + 2 N/O (KP2)

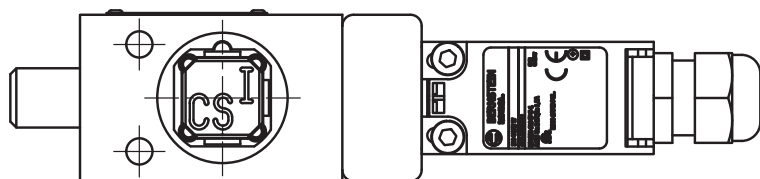
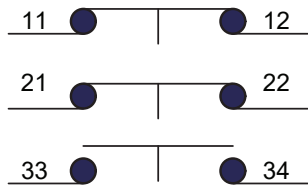

Key Trapped, Bolt is Retracted: 2 N/O + 1 N/C (KP1)
4 N/O + 2 N/C (KP2)

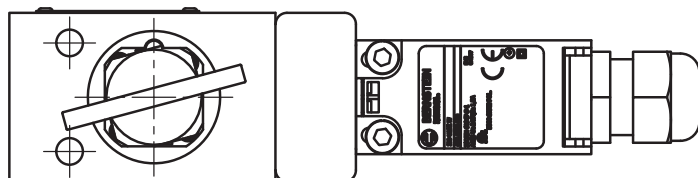
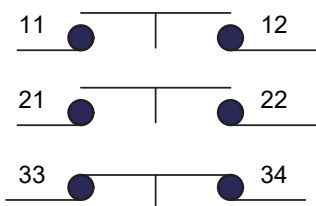

KP Bolt Interlock with Safety Switch

ORDER INFORMATION

| | Component type | 1 | 2 | 3 | 4 | 5 | 6 | 7 |
|-------------|----------------|---|----|---|-----|----|---|-----|
| Part number | KP | | | | | | | |
| Example | KP | 1 | FS | B | 6.4 | FR | 4 | TBA |

| | | |
|---|--|--|
| 1 | Switch specification | 1 = 2 NC/1 NO ⁽²⁾ 2 = 4 NC/ 2NO ⁽²⁾ |
| 2 | Lock portion type | FS ⁽¹⁾ / Q ⁽¹⁾ |
| 3 | Material | B = Brass / S = Stainless steel |
| 4 | L dimension (bolt length when retracted) in mm | 0 / 6.4 / 12.7 / 19.1 / 25.4 ⁽¹⁾ |
| 5 | Switch entry | RE = Rear entry / FR = Front entry ⁽⁵⁾ |
| 6 | Form | 1 / 2 / 3 / 4 ⁽⁴⁾ |
| 7 | Lock portion symbol | FS ⁽¹⁾ up to 3 characters / Q ⁽¹⁾ up to 6 characters |

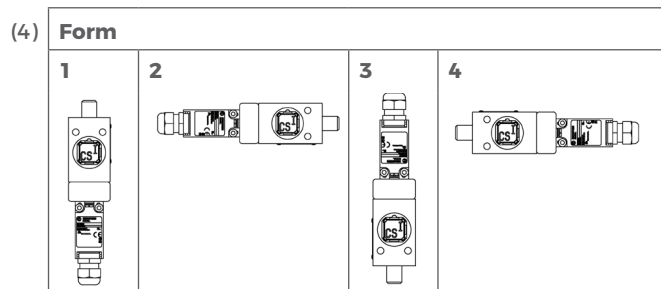
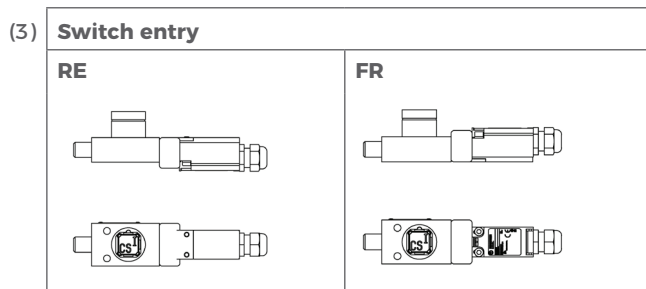
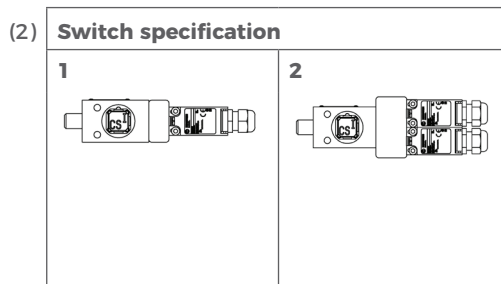
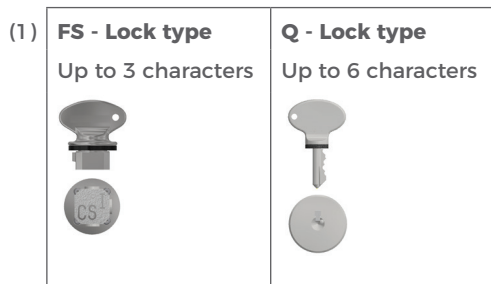

Special construction available upon enquiry

ACCESSORIES

| | | |
|--|----------------|--------------------|
|  | Product | Part number |
| | Flip Cap | FLIP-S |

CONTACT INFORMATION

Castell Safety

The Castell Building, 217 Kingsbury Road, London, NW9 9PQ UK
t: +44 (0)20 8200 1200 | f: +44 (0)20 8205 0055 | e: sales@castell.com