

B Key Exchange Box



The B key exchange box is designed to enable the sequential release of keys (maximum 5) by the insertion of one or more initial key(s). The need for this type of product usually arises when there are multiple access points to the hazardous area. The unit will generally act as the link between the isolation locks and the access products. The product is supplied on a slim enclosure suitable for surface or panel mounting, and is available in different configurations of locks.

OPERATION

Castell Key Exchange Boxes are used in various applications to control multi-door access to hazardous areas.

B key exchange box, horizontal mount (1 key free - 2 keys trapped)

1 1 key free, 2 keys trapped

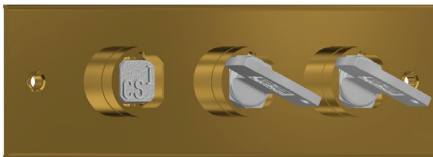

While 1 key is free which is usually used in power isolation, 2 keys are trapped.

2 Insert and turn free key, then turn and release trapped keys in a sequence

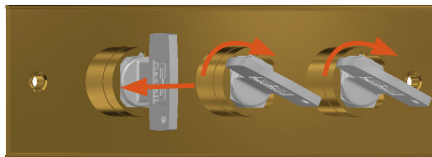

By inserting and turning the free key in the B key exchange box, you may sequentially release the trapped keys. The released keys may be inserted and turned in the access door locks to gain entrance to the hazardous area.

3 1 key is trapped, 2 keys released

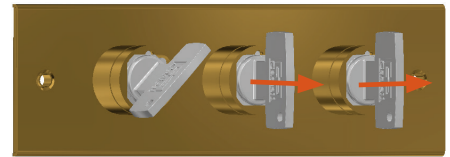

The inserted key remains trapped until all released keys are returned to their original position.

The B key exchange box is available in different combinations of free and trapped keys and also in a vertical mounting version.

B Key Exchange Box

USAGE

B key exchange boxes should be used to allow a safe access to potential hazardous and dangerous areas with one or more access points.

 The B key exchange box is not designed for security purposes, such as access to a building.

No hazardous substances were used in the manufacture of this product.

INSTALLATION

The B key exchange box should normally be mounted on a static frame using suitable fasteners. Please refer to the drawing on page 4 for maximum and minimum mounting distance. The B key exchange boxes are available in horizontal and vertical mounting versions.

 **IMPORTANT:** The B key exchange box should be mounted using anti-tamper fasteners to prevent unauthorised removal.

 The B key exchange box must be installed by a competent and qualified person who has read and understood these instructions. Please retain this document in your technical file.

 The manufacturer should be consulted when use in a corrosive environment is planned.

MAINTENANCE

Periodic visual checks should be carried out by the site manager/safety officer.

Do not lubricate lock barrel with oil or grease, use CK dry powder graphite if necessary.

 In case of defects being detected please contact your nearest Castell Support Department for further actions. Please see Contact section for contact details.

 The interlock must be inspected every 6 months. Safety checks should include ensuring the keys can only be removed in the correct safety operating conditions (see page 1).

B Key Exchange Box

TECHNICAL DATA

Temperature rating	Minimum: -40°C [-40°F] ice free for Q & FS lock type
	Maximum: 107°C [224.6°F] for Q lock type/140°C [284°F] for FS lock type or 288°C [550°F] upon request
Type of mounting	Panel mount using suitable fasteners (please refer to drawing on page 4 for more details)
Weight	Brass: 1 kg for 2 lock portions, add 0.5 kg per additional portion
	Stainless steel: 1 kg for 2 lock portions, add 0.5 kg per additional portion
Material	Brass
Shock & vibration	In accordance with BS EN 50155 & IEC 61373
PL rating	PLd
B10d	2,500,000

APPLICATION

A typical application of the B key exchange box is machine guarding with one or more access points to the hazardous area.

The B key exchange box safety component is used as a part of an integrated safety system, which ensures a machine is shut down, before access to the hazardous area is allowed. The system involves a KS key switch for the electrical supply and typically more than one AIE access interlocks for full body access.

The removal of the isolation key from the key switch isolates the electrical supply to the machine. This key is taken to the B key exchange box to release the trapped keys. The released keys are used to gain access through the AIE door interlocks.

The machine cannot be restarted until all keys are returned to the key exchange box and the power isolation key is removed and replaced in the KS key switch.

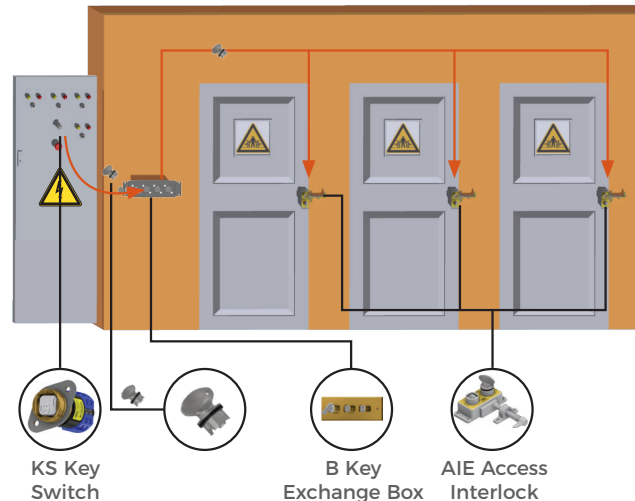

B Key Exchange Box

DRAWING

Dimensions: in mm

Note: For safe mounting, use security screws

B key exchange box, horizontal mount

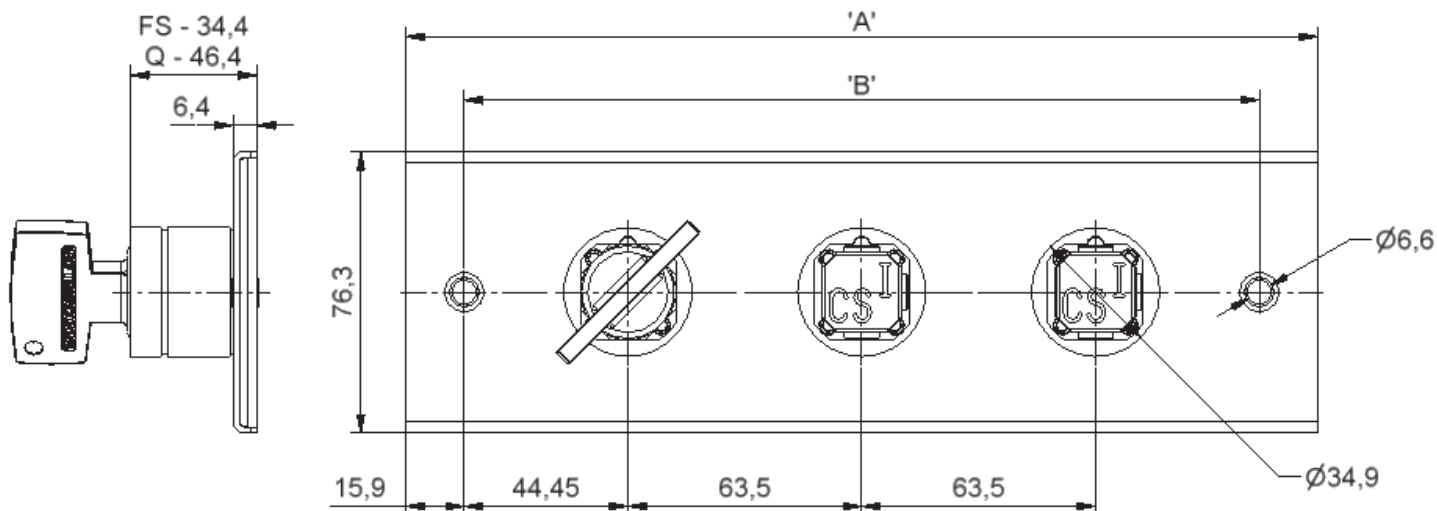



B Key Exchange Box

ORDER INFORMATION

Component type
1 **2** **3** **4** **5**
Part number - - - -
Example - - - /
6
 Free key symbol(s)
7
 End key symbol(s)

1	Lock portion type	FS ⁽¹⁾ / Q ⁽¹⁾
2	Material	B = Brass
3	Mounting	H = Horizontal V = Vertical
4	Number of free keys	Please specify
5	Number of trapepd keys	Please specify
6	Lock portion symbol(s) - Free key(s), all to be advised separately	FS ⁽¹⁾ up to 3 characters / Q ⁽¹⁾ up to 6 characters
7	Lock portion symbol(s) - Trapped key(s), all to be advised separately	FS ⁽¹⁾ up to 3 characters / Q ⁽¹⁾ up to 6 characters

(1)

FS - Lock type Up to 3 characters 	Q - Lock type Up to 6 characters 
--	---

Special construction available upon enquiry

ACCESSORIES

	Product	Part number
	Flip Cap	FLIP-S

CONTACT INFORMATION

Castell Safety
 The Castell Building, 217 Kingsbury Road, London, NW9 9PQ UK
 t: +44 (0)20 8200 1200 | f: +44 (0)20 8205 0055 | e: sales@castell.com