

# X Key Exchange Box

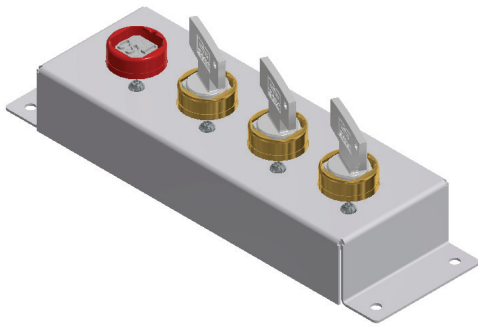

The X key exchange box is designed to enable the release of keys by the insertion of one or more primary key(s). The need for this type of product usually arises when there are multiple points of entry. The unit will generally be the link between the isolation locks and the access products. The product is supplied in an enclosure suitable for surface mounting and is available in a number of configurations and number of locks.

## OPERATION

Castell Key Exchange Boxes are used in various applications to control (multi-)door access to hazardous areas.

### X key exchange box, horizontal mount

**1** 1 key is free, 3 keys are trapped.

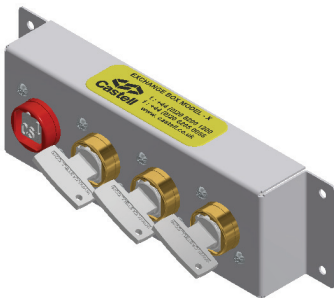

While 1 key is free which is usually used in a power isolation, 3 keys are trapped.

**2** Insert and turn the free key, then turn and release the trapped keys in a sequence.

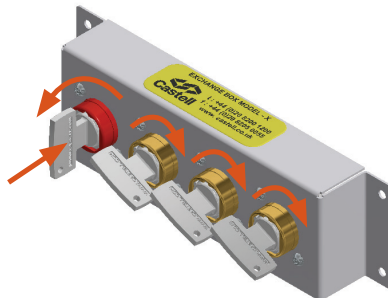

By inserting and turning the free key in the X key exchange box, trapped keys can be sequentially released. The released keys can be used in the access door locks to gain access to the hazardous area.

**3** 1 key is trapped, 3 keys are released

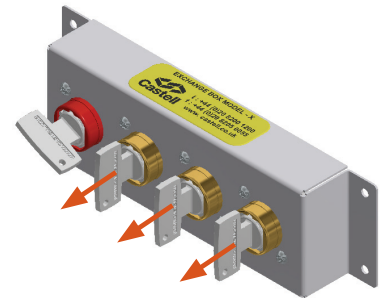

The inserted key stays trapped until all released keys are returned to their original position.

The X key exchange box is available in different combinations of free and trapped keys and also available in a vertical mounting version.

## USAGE

X key exchange boxes should be used to allow a safe access to potential hazardous and dangerous areas with one or more access points.

 The X key exchange box is not designed for security purposes, such as access to a building.

No hazardous substances were used in the manufacture of this product.

## INSTALLATION

The X key exchange box should normally be mounted on the static frame using suitable fasteners. Please refer to the drawing on page 4 for maximum and minimum mounting distance and hole details. The X key exchange boxes are available in horizontal and vertical mounting versions. Anti vibration pads should be used on machines that generate a high level of vibration.

 You must use M6 anti-temper stainless steel screws secured using threadlock set to a torque of 5 N/M.

 The X key exchange box must be installed by a competent and qualified person who has read and understood these instructions. Please retain this document in your technical file.

 The manufacturer should be consulted when use in a corrosive environment is planned.

## MAINTENANCE

Periodic visual checks should be carried out by the site manager/safety officer.

Do not lubricate lock barrel with oil or grease, use dry graphite powder if necessary.

 In case of defects being detected please contact your nearest Castell Support Department for further actions. Please see Contact section for contact details.

 The interlock must be inspected every 6 months. Safety checks should include ensuring the keys can only be removed in the correct safety operating conditions (see page 1).

## TECHNICAL DATA

<b>Temperature rating</b>	Minimum: -40°C [-40°F] ice free for Q & FS lock type
	Maximum: 107°C [224.6°F] for Q lock type/140°C [284°F] for FS lock type or 288°C [550°F] upon request
<b>Type of mounting</b>	Surface mount using suitable fasteners (please refer to drawing on page 4 for more details)
<b>Weight</b>	Brass: 1 kg for 2 lock portions, add 0.5 kg per additional portion
	Stainless steel: 1 kg for 2 lock portions, add 0.5 kg per additional portion
<b>Material</b>	Brass or stainless steel
<b>B10d</b>	2,500,000
<b>Shock &amp; vibration</b>	EN 60068
<b>PL rating</b>	PLd

## APPLICATION

The X Key Exchange Box Safety component is used as part of an integrated safety system.

A typical application of the X key exchange box is machine guarding with one or more access points to the hazardous area.

The key exchange box is used as a part of a safety system, which ensures a machine is shut down, before access to the hazardous area is allowed. The system involves a KS key switch for the electrical supply and typically more than one AIE access interlocks for full body access.

The removal of the isolation key from the key switch isolates the electrical supply to the machine. This key is taken to the X key exchange box to release the trapped keys. The released keys are used to gain access through the AIE door interlocks.

The machine cannot be restarted until all keys are returned to the key exchange box and the power isolation key is removed and taken to the KS key switch.

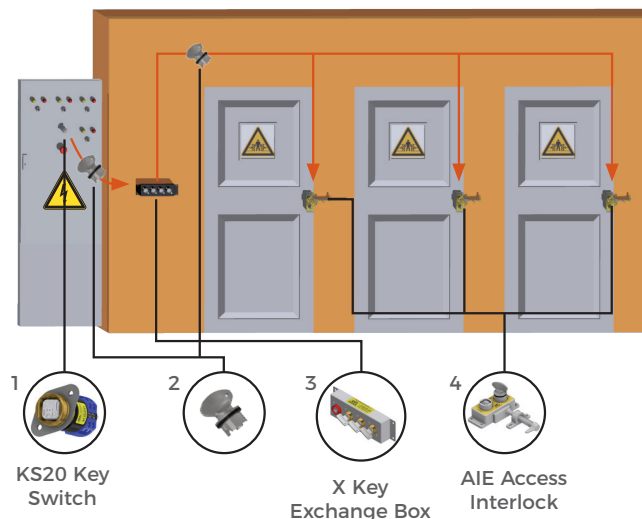

# X Key Exchange Box

## DRAWING

Dimensions: in mm

**Note:** For safe mounting, use security screws

### X key exchange box, horizontal mount

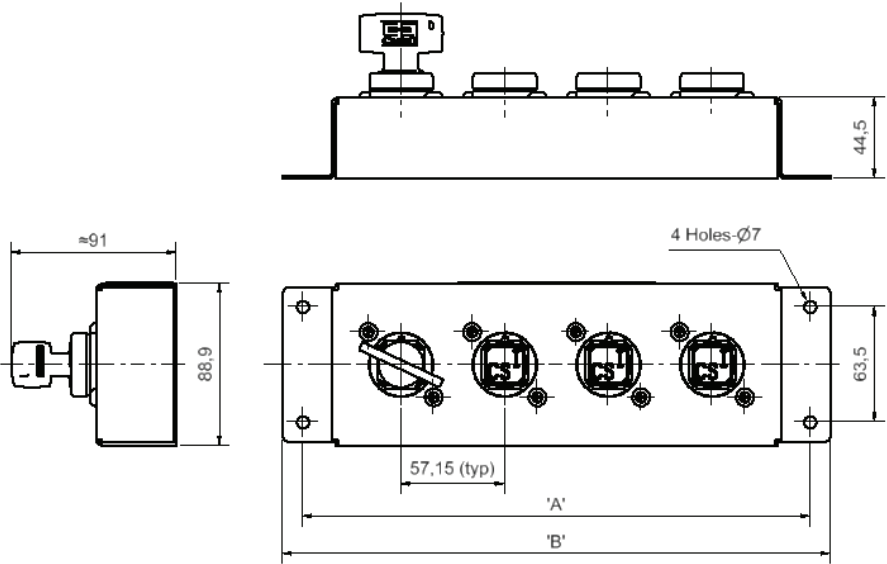



Table		
Fronts	'A'	'B'
2 Front	165.15	190.55
3 Front	222.3	247.7
4 Front	279.45	304.85
5 Front	336.6	362
6 Front	393.75	419.15
7 Front	450.9	476.3
8 Front	508.05	533.45
9 Front	565.2	590.6
10 Front	622.35	647.75
11 Front	679.5	704.9

**4 Front Exchange Box Shown - 1 Key In, 3 Keys Out**

## ORDER INFORMATION

**Component type**      **1**      **2**      **3**      **4**      **5**  
**Part number**     -   -  -  -   
**Example**         -   -  -  -   
**6**  **Free key symbol(s)/keys in**      **7**  **Trapped key symbol(s)/keys out**

<b>1</b>	<b>Lock portion type</b>	FS <sup>(1)</sup> / Q <sup>(1)</sup>
<b>2</b>	<b>Material</b>	B = Brass S = Stainless steel
<b>3</b>	<b>Mounting</b>	H = Horizontal V = Vertical
<b>4</b>	<b>Number of free keys (keys in)</b>	Please specify
<b>5</b>	<b>Number of trapped keys (keys out)</b>	Please specify
<b>6</b>	<b>Lock portion symbol(s), free keys - all to be advised separately</b>	FS <sup>(1)</sup> up to 3 characters / Q <sup>(1)</sup> up to 6 characters
<b>7</b>	<b>Lock portion symbol(s), trapped keys - all to be advised separately</b>	FS <sup>(1)</sup> up to 3 characters / Q <sup>(1)</sup> up to 6 characters

(1)	<b>FS - Lock type</b> Up to 3 characters	<b>Q - Lock type</b> Up to 6 characters
		

Special construction available upon enquiry

## ACCESSORIES

	<b>Product</b>	<b>Part number</b>
	Flip Cap	FLIP-S

## CONTACT INFORMATION

### Castell Safety

The Castell Building, 217 Kingsbury Road, London, NW9 9PQ UK  
t: +44 (0)20 8200 1200 | f: +44 (0)20 8205 0055 | e: sales@castell.com