

# KL Dual Key Bolt Interlock

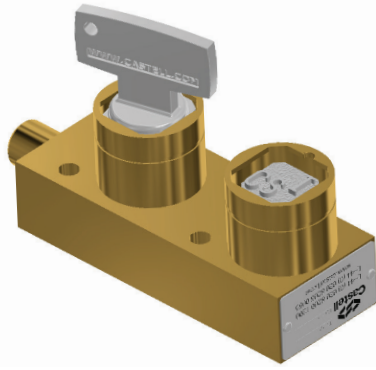

The KL Dual Key Bolt Interlock is a key operated mechanical bolt interlock suitable for the control of electrical switchgear. The interlock is used to control the rotation or movement of operating handles or toggles of electrical switchgear and is manufactured in brass or stainless steel. The KL Bolt Interlock is available in a double key or exchange key condition.

## OPERATION

The Castell KL Bolt Interlock range is used on control of switchgear to inhibit movement of cams, toggles or levers.

### KL Dual Key Bolt Interlock, exchange key condition

- 1** Key A (Primary) is free while key B (Secondary) is trapped, bolt is retracted

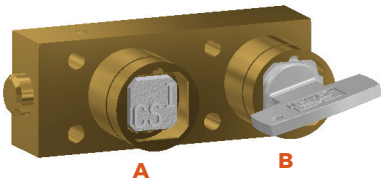

When switch is on, the bolt is retracted and key B is trapped in the lock.

- 2** Insert and turn key A to extend bolt and allow the release of Key B

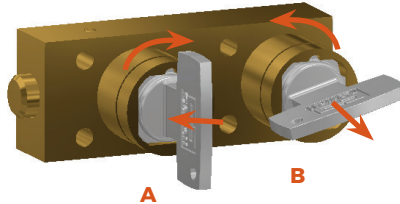

When switch is turned off, the bolt is extended to lock it in position. Key B can now be removed and Key A is trapped.

- 3** Key A is trapped, Key B is free and bolt extended

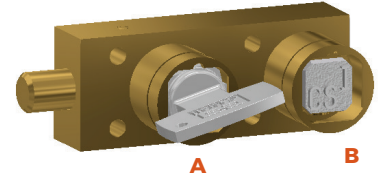

Key A stays trapped while bolt is extended. Key B is free. Switch remains locked in off position.

### KL Dual Key Bolt Interlock, double key condition

- 1** Key A (Primary) and key B (Secondary) are trapped, bolt is retracted

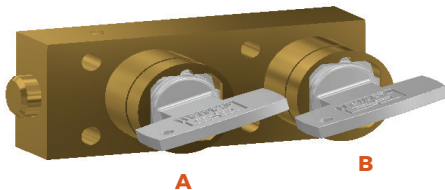

When switch is on, the bolt is retracted and keys A and B are trapped in the lock.

- 2** When switch turned to off position, keys A and B are turned extending the bolt

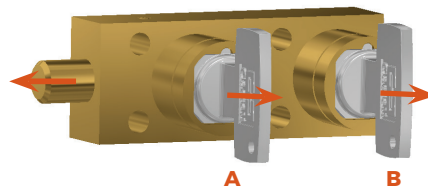

The bolt is extended to lock switch in off position. Both keys can now be released.

- 3** Keys A and B are free and bolt is extended

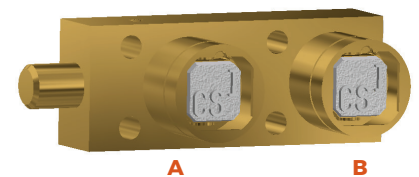

Switch remains locked in off position.

The length of the bolt can be varied to suit the application but travel of the bolt is always 19.05 mm.

## USAGE

The KL Dual Key Bolt Interlock should be used as a part of a safety system to allow safe control of disconnect switches.





-  The KL Bolt Interlock is not designed for security purposes, such as access to a building.
-  The KL Bolt Interlock is not recommended to interlock gates or doors. Please refer to the AIE Access Interlock.

No hazardous substances were used in the manufacture of this product.

## INSTALLATION

The housing of the KL Bolt Interlock should normally be mounted to a panel using suitable fasteners. Please refer to drawing on page 4 for more installation details.



If required, mounting kits are available from switchgear equipment suppliers.

-  The KL Bolt Interlock must be installed by a competent and qualified person who has read and understood these instructions. Please retain this document in your technical file.
-  Force required to shear lock bolt is 30KN for stainless steel and 19KN for brass interlocks.
-  You must use M6 anti-tamper stainless steel screws secured using threadlock set to a torque of 5 N/M.
-  The manufacturer should be consulted when use in a corrosive environment is planned.

## MAINTENANCE

Periodic visual checks should be carried out by the site manager / safety officer.

Do not lubricate lock barrel with oil or grease, use CK dry powder graphite if necessary.

-  In case of defects being detected please contact your nearest Castell Support Department for further actions. Please see Contact section for contact details.
-  The interlock must be inspected every 6 months. Safety checks should include ensuring the keys and lock bolt can only be operated in the correct safety operating conditions (see page 1).

## TECHNICAL DATA

<b>Temperature rating</b>	Minimum: -40°C [-40°F] ice free for Q & FS lock type
	Maximum: 107°C [224.6°F] for Q lock type/140°C [284°F] for FS lock type
<b>Type of mounting</b>	Surface mount using suitable fasteners (please refer to drawing on page 4 for more details)
<b>Weight</b>	1.4 kg
<b>Material</b>	Brass/Stainless steel
<b>B10d</b>	2,500,000
<b>PL rating</b>	PLd
<b>Shock &amp; vibration</b>	In accordance with BS EN 50155

## APPLICATION

KL Dual Key Bolt Interlock safety component is used as part of an integrated safety system. In this application the electrical supply to the machine is switched on and the access doors to the hazardous area are locked closed.

Keys A and B are trapped in the KL Bolt Interlock, preventing access to the machine area. To enter the area, the electrical supply must be turned off. Turning and releasing the keys in the KL Interlock will extend the bolt locking the disconnecter in the off position.

The released keys can now be taken to the machine area to gain access via the AI Access Interlocks.

The disconnecter cannot be switched on until both access doors are locked closed and both keys returned to the KL Interlock.

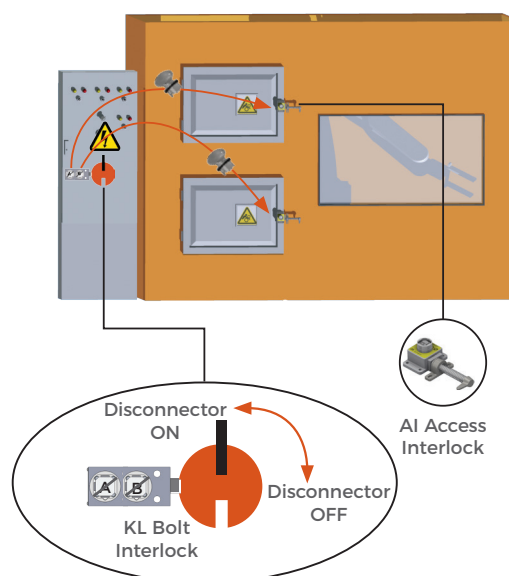

# KL Dual Key Bolt Interlock

## DRAWING

Dimensions: in mm

**Note:** For safe mounting, use security screws

### KL, form 4

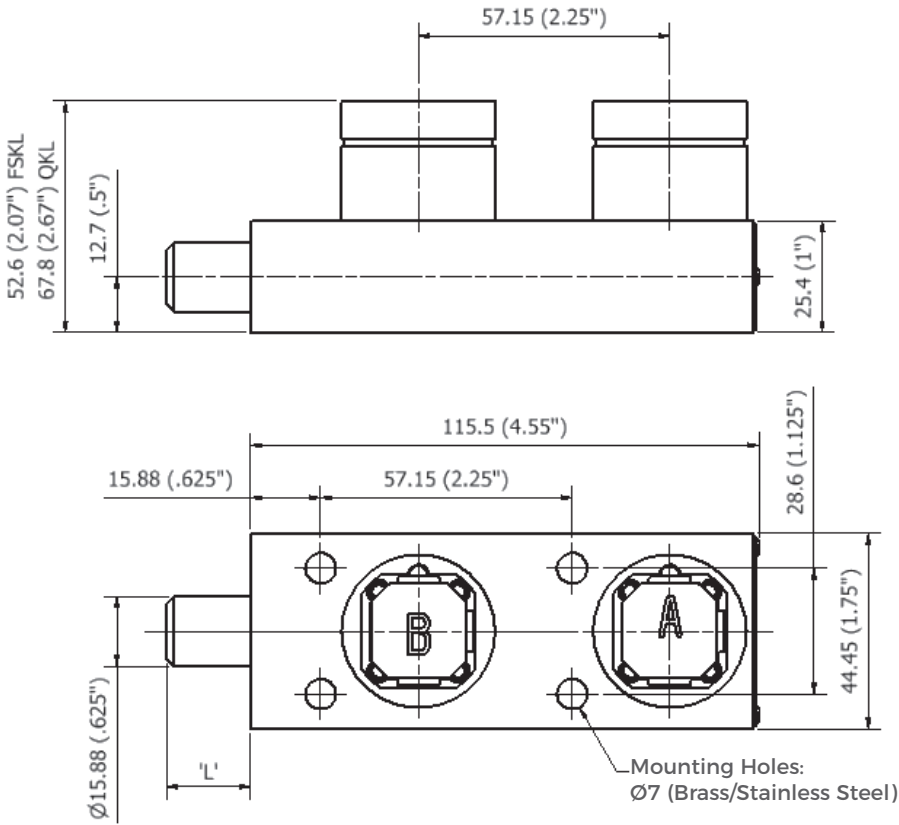





L Dimension Retracted bolt length (in mm)	Extended bolt length (in mm)
0	19.05
6.40	25.40
12.70	31.75
19.05	38.10
25.40	44.45

## ORDER INFORMATION

	<b>Component type</b>	<b>1</b>	<b>2</b>	<b>3</b>	<b>4</b>	<b>5</b>	<b>6</b>
Part number	KL						
Example	KL	FS	B	1S	6.4	1	D
		7		Primary key symbol		8	
							Secondary key symbol

<b>1</b>	Lock portion type	FS <sup>(1)</sup> / Q <sup>(1)</sup>
<b>2</b>	Material	B = Brass / S = Stainless steel
<b>3</b>	Number of secondary lock portions	1S = 1 secondary key (2 locks in total) 2S = 2 secondary keys (3 locks in total) 3S = 3 secondary keys (4 locks in total)
<b>4</b>	L dimension (bolt length when retracted) in mm	0 / 6.4 / 12.7 / 19.1 / 25.4
<b>5</b>	Form	1 / 2 / 3 / 4 <sup>(2)</sup>
<b>6</b>	Key condition	D = double key condition / E = exchange key condition (see operation details, page 1)
<b>7</b>	Lock portion symbol: Primary key (closest to bolt)	FS <sup>(1)</sup> up to 3 characters / Q <sup>(1)</sup> up to 6 characters
<b>8</b>	Lock portion symbol: Secondary key (furthest from bolt)	FS <sup>(1)</sup> up to 3 characters / Q <sup>(1)</sup> up to 6 characters

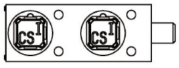
(1)	<b>FS - Lock type</b> Up to 3 characters	<b>Q - Lock type</b> Up to 6 characters
		

(2)	<b>Form</b>			
	<b>1</b>	<b>2</b>	<b>3</b>	<b>4</b>
				

Special construction available upon enquiry

## ACCESSORIES

	<b>Product</b>	<b>Part number</b>
	Flip Cap	FLIP-S

## CONTACT INFORMATION

### Castell Safety

The Castell Building, 217 Kingsbury Road, London, NW9 9PQ UK  
t: +44 (0)20 8200 1200 | f: +44 (0)20 8205 0055 | e: sales@castell.com